

# MERCIO

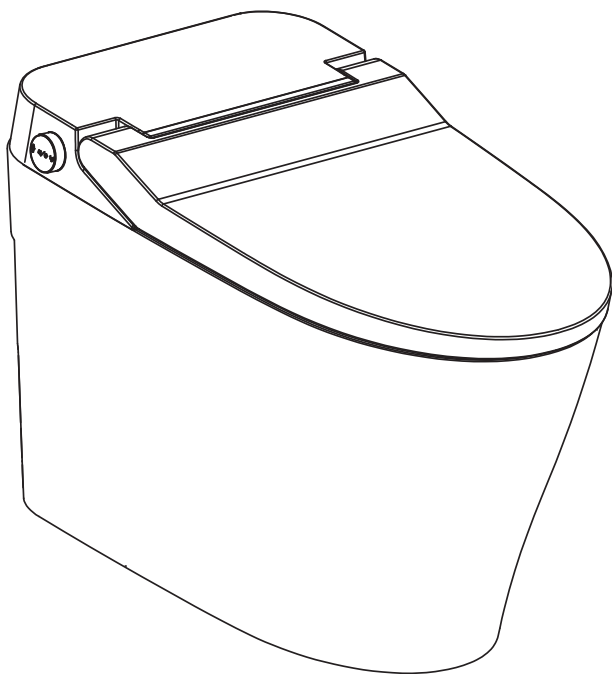

**KYP**

Intelligent Toilet- User &  
Installation Manual

# Content

---

Thank you for purchasing our smart toilet series.

To ensure safety, please read this installation instruction manual carefully and install this product correctly and safely. MERCIO shall not be held liable for any accidents or injuries resulting from the use of non-specified parts or failure to follow these installation instructions.



---

Safety Precautions .....	01
Part Identification .....	09
Packaging List .....	10
Attention Before Installation .....	11
Installation Method .....	12
Precautions Before Use .....	16
Remote Control Instructions .....	18
Functional List .....	25
Basic operations .....	26
Maintenance Instructions .....	28
Troubleshooting .....	31
Technical Parameter .....	33
Product Environmental Information .....	34
After-Sales Service .....	35

In order to avoid personal injury or financial loss, the following distinctions and signs are made.







The following are all important safety issues, please strictly observe them.

- According to the degree of harm or damage caused by wrong usage, it can be divided into the following levels:

 DANGER	Indicates a hazardous situation which, if not avoided, will result in death or serious injury.
 WARNING	Indicates a hazardous situation which, if not avoided, could result in death or serious injury.
 CAUTION	Indicates a hazardous situation which, if not avoided, could result in minor or moderate injury or property damage.

- The following icons are used to illustrate

 Prohibition	Actions that are NOT allowed	 Mandatory	Actions that MUST be carried out.
---	------------------------------	---	-----------------------------------

	Indicates actions that are prohibited.		keep away from high temperature and inflammable objects
	Do not touch with wet hands		Prohibition of watering
	Must connect to the earth wire		
	Installation must be carried out by a licensed plumber and electrician.		



## WARNING



Do not spray water

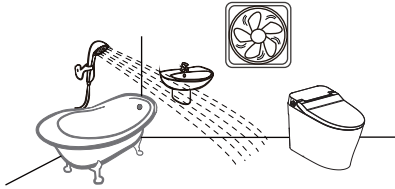

This product is an electric product, so do not place where it is splashed with water or has a high humidity. When using in the bathroom, please install a ventilation fan or a ventilation port. Keep the air circulation in the bathroom.  
--Otherwise, it may lead to a fire or electric shock.



Prohibition of watering

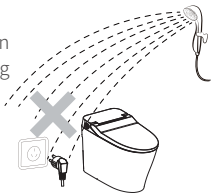

Prohibition of drenching: Do not spray water or detergent on the power plug of the product.  
--Otherwise may result in fire, electric shock, and accidents.



240V~   
50Hz   
More than 10A (inclusive)



This product must be connected to a dedicated power outlet rated at 240V AC, 50Hz, with a minimum current capacity of 10A. The outlet **MUST** be properly grounded.  
--Failure to do so may result in fire or electric shock.  
--When the power exceeds the socket requirements, it will heat up and cause a fire.



WARNING

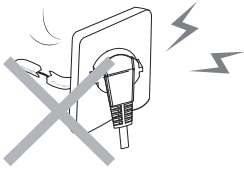

Do not use loose or faulty outlets.  
--Failure to do so may result in fire or electric shock.

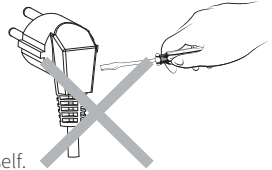

If the power cord is damaged, do not disassemble it yourself.

It must be replaced by the manufacturer's maintenance department or a professional.



Do not touch  
with wet hands.

Do not use wet hands to insert or  
remove power plug.  
--It may lead to electric shock.

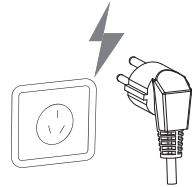

Must connect to the  
ground wire

Please check if the power outlet is connected to the  
ground wire or not.  
--If the ungrounded product fails or leaks, it may  
cause electric shock.



## WARNING

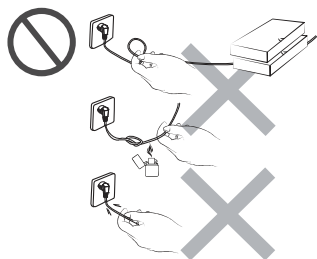

Do not damage the power cord

- Do not damage, do not process, do not heat;
  - Do not bend, do not curl and bind, do not pull;
  - Do not place heavy objects on the power cord.
- Do not continue to using the damage product which may result in fire, electric shock, short circuit and other situation.



High temperature flammable materials are prohibited

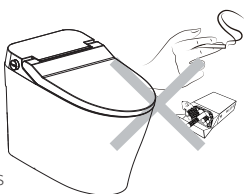

Please do not put the flaming products such as cigarettes close to or into the product.



Prevention of low temperature burn

If touching the toilet seat prolonged, a certain area of skin may be burned by low temperature heat.

Please keep the seat temperature LOW or OFF when using the toilet seat.

-- Children, the elderly, etc. who can not adjust the temperature to an appropriate level by themselves;

-- Persons who are unable to move freely, such as the sick or the disabled;

-- Heavy drinking and excessive tiredness caused by hypnotic drugs (e.g. sleeping pills, cold medicine) .



WARNING



It is prohibited to disassemble or modify this product by yourself

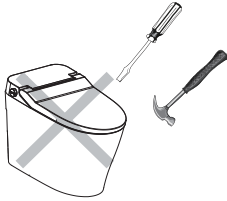

Prohibit disassembly: It is absolutely forbidden to disassemble, repair or modify this product by yourself. Failure to do so may result in fire, electric shock and other accidents.



When the following occurs, please remove the power plug and close the inlet valve

- Smoking
- From the pipeline, product leaks from inside out
- The product temperature is abnormally high
- An abnormal sound or smell



#### Water Connection Precautions

Do not use water other than tap water.

--Otherwise, skin infection or product failure may occur.



## ATTENTION



Please use the new hose to assembly that comes with the appliance. The old hose cannot be reused.

--Otherwise it will affect the performance of the product and cause the product leakage.

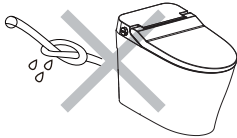

Do not twist or break the inlet pipe. The bending angle of the hose should not exceed 90°. Otherwise, it may cause the water does not flow in or the product leakage.

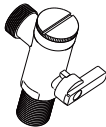

Please tighten well when installing the inlet valve. Otherwise it will cause water leakage.

--When leaking, please close the inlet valve to prevent damage from freezing.

--Freezing will cause water ingress and internal damage, which will cause product leakage.

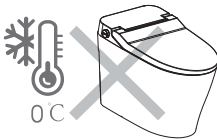

Do not use at temperatures below 0°C .

-- Below 0°C, please refer to P30 [Long Term Non-Use] , water should be drained from the product to prevent freezing and cracking.



ATTENTION



Do not hit the product with violence to prevent leakage.

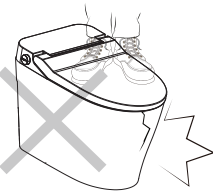

Do not place heavy objects on the seat cover, or stand on the seat cover, and do not hit the product with violence.  
--Product fragmentation may cause personal injury.  
--Toilet fragmentation may cause problems of water seepage in the room.



Do not put your fingers or other objects in or block the warm air outlet.  
--Otherwise it will cause burn, electric shock or burning.



Please use the neutral kitchen cleaner during maintenance.  
The following items are prohibited to use: Toilet cleaning agent, household cleaning agent, volatile agents, banana oil etc.  
--Otherwise, it may damage the plastic parts, and the shatter from them will cause personal injury.  
--Otherwise, the inlet pipe may be damaged, which will result in leaking.



## ATTENTION



For persons with disabilities, physical sensory, mental and general lack of experience (including children). Please use this product under supervision .

Do not allow children to play with this product. Please do not continue to use when the product is out of order, please contact after-sales service personnel for maintenance.

--Using the product in the event of a malfunction can cause problems such as fire accident, electric shock, or leaking of room. Please contact after-sales service personnel for maintenance.



Do not use the toilet bowl to flush anything other than excreta or toilet paper.

--Otherwise, it may lead to toilet block, sewage overflow.





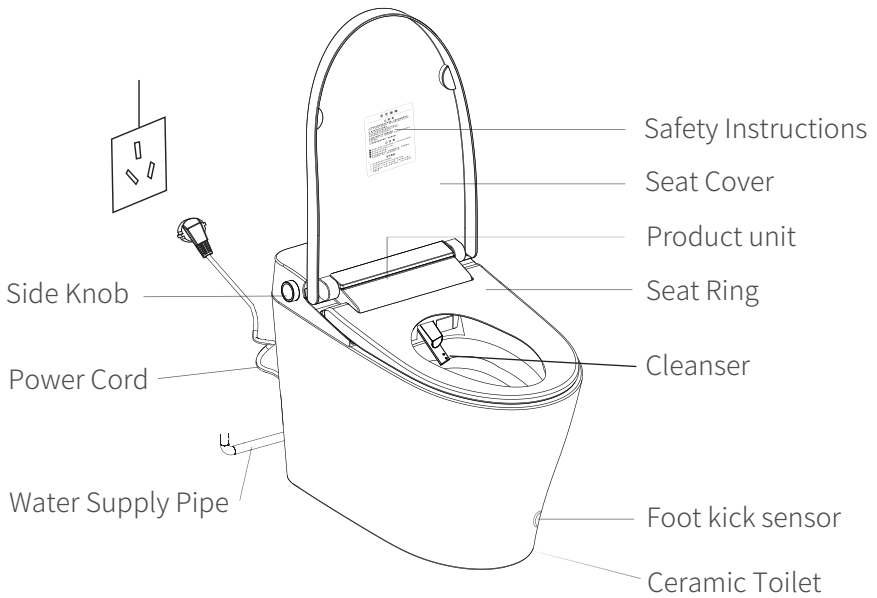

Please do not put newsprint, paper urinals, sanitary napkins and other easy-to-block items into the toilet seat.

Otherwise, the toilet may be blocked and the sewage may overflow.



- The appearance and function are based on the actual object.

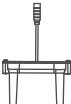
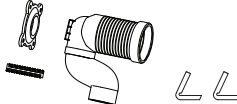
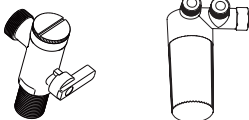

	Complete Machine
 	Remote Control Module(The appearance and function are based on the actual object)
	External battery box
	Oil sludge base
	1/2 inch to 1/2 inch angle valve/Filter
	User manual/Certificate

■ The appearance and function are based on the actual object.

Installation Space

- While ensuring the required installation space, please make sure that the installation of the product does not affect doors open, etc.. The water inlet pipe should be above 150mm off the ground.
- Before installation, please confirm the location of sewage outlet and wax seal (Please refer to the indication shown on the right) .

Water Pressure

- The lowest necessary water pressure: 0.07 MPA (0.7 kgf / cm<sup>2</sup>); flow rate  $\geq$  20L / Min (flow rate > 20L per minute) , if the pressure is not reached, the product can not work normally (special measuring tools).
- When used simultaneously with other products such as water taps, the first requirement shall also be met.

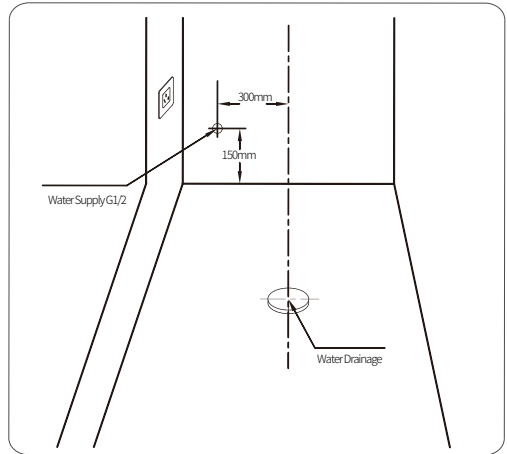

Installation Drawing

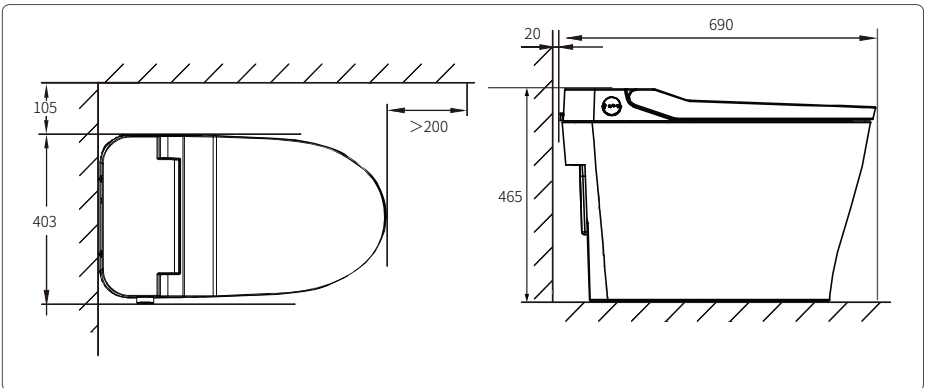

Note: This is the Installation Drawing

## TOOLS AND MATERIALS REQUIRED (NOT SUPPLIED)

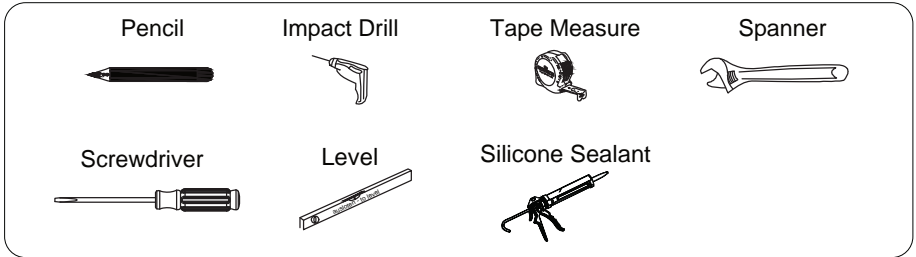

### ( 1 ) installation of seal ring and ceramics

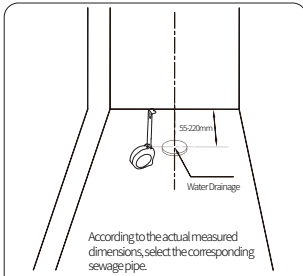

1. Measure two points 55-220mm away from the wall with dimensions

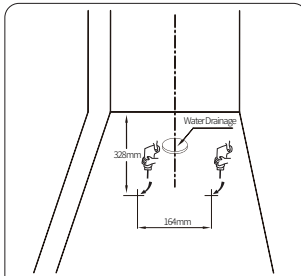

2. Two points are 164mm apart and mark the points with a pen, then use an electric drill to drill holes in the floor of the dots.

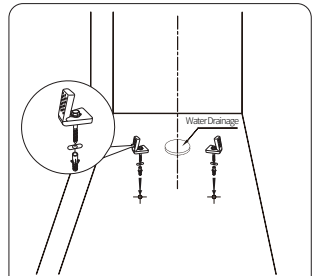

3. Mounting brackets are bolted to the floor

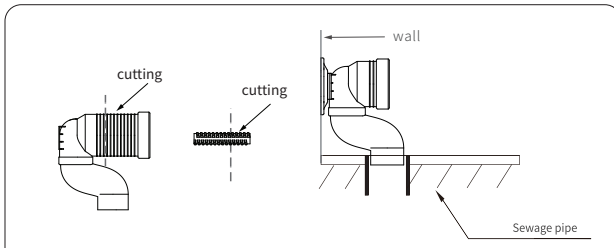

4. Trim the drain adapter and fixing column to match the spacing between the drain holes. Insert the adapter into the ground drain outlet. Next, attach the fixing column and base to the wall using expansion screws.

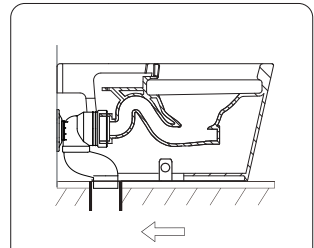

5. Position the machine so that its nozzle is aligned with the mark on the ground, and then push it gently.

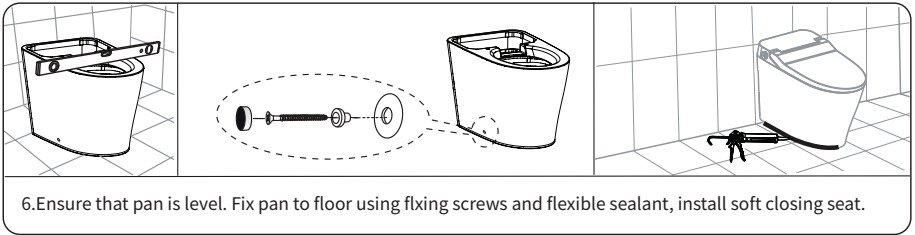

Match:

 65-95	 85-105	 95-125
 105-135	 135-165	 155-185

( 2 ) connecting water supply pipes

- Turn off the water source.
- After installing the angle valve, open the angle valve switch for more than 1 minute to prevent it from being not used for a long time, and there is dirt inside.
- Connect the components according to the diagram.
- Carefully tighten the installation area and visually check for leaks.

**Attention:**Use brand-new water pipes.

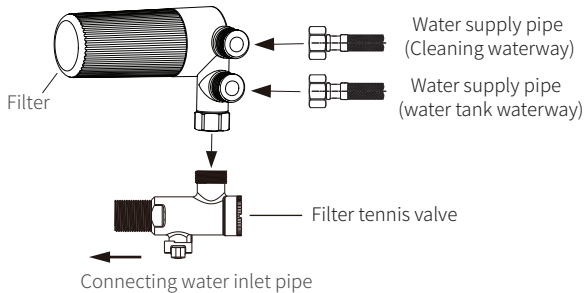

### ( 3 ) Connect the power supply

Open the angle valve and plug in the product. The power cord must be connected to a socket with 240V~, 50Hz, 10A above (including) and safe grounding.

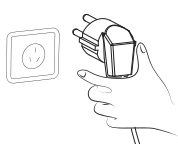

240V~   
 50Hz   
 More than 10A (inclusive)

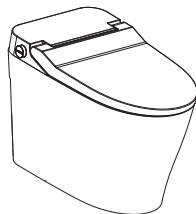

(Photo 6)



Attention

- Do not spray water on the toilet seat or the dry air outlet.
- If installed in cold weather environment, please keep it in a warm room for 2 hours before installation.
- The company shall not be held liable for any accident or injury caused by failure to comply with the installation instructions or by failure to use specified components at time of installation.

### ( 4 ) Inspection list after complete installation

- ★ After the installation is completed, it must be put into trial operation and checked one by one according to the inspection list.

#### Inspection List

- Whether it is connected to the power socket, which can provide the safe grounding of 240V~, 10A, 50Hz.
- The plug and socket can not be loosened.
- Make sure the main water inlet valve is open.
- Check whether the joints are tight, fixed, and whether there is leakage (such as cleaning filter, water supply hoses and fixed springs, nuts, etc.) .
- Whether the power indicator lights up.
- Whether the sprinkler system is leaking. Dry the applicator and check for leaks with toilet paper.
- Product functions are normal: Rear and Front (including water pressure adjustment) , warm air drying (including warm air intensity adjustment) , water temperature and seat temperature adjustment, nozzle self-cleaning, automatic deodorant, seat, cover, automatic flip, remote control and the display of the remote control are normal.

★ The above series of actions should be checked.

Installation of main remote control

- Choose suitable and dry plane, tear the sponge double-sided adhesive, and fix the remote control bracket.
- Insert the remote control into the bracket. (It is recommended to fix the remote control in a ventilated and easy-to-use position. If you do not use it for a long time, please remove the battery from the remote control.) (see right picture)

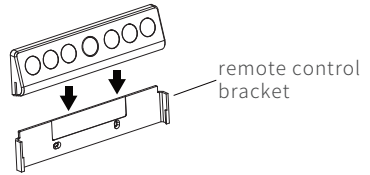

Precautions Before Use



When it thunders, please disconnect the power plug from the socket.  
-- Or there may be a malfunction.



Prohibit

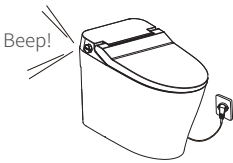

After completed installation, plug in the outlet, power on and the machine shall run a self-test. After completed the self-test, a "Beep" sound should emitted which indicates that the whole machine has been electrified

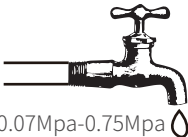

0.07Mpa-0.75Mpa

Tap Water pressure must be at the range of 0.07MPa to 0.75MPa when using this product.

## Precautions Before Use

- During daily use, please avoid spraying water onto the body of the machine to prevent damage from internal water.
- After the remote control has been used for a long time, the exhaustion of the battery may affect the signal reception. In this case, the battery should be replaced.
- During the process of turning over the seat cover and the seat ring, foreign objects should be prevented from being stuck on the moving track of the cover and the ring.  
-- Failure to do so may cause a malfunction.



Prohibit

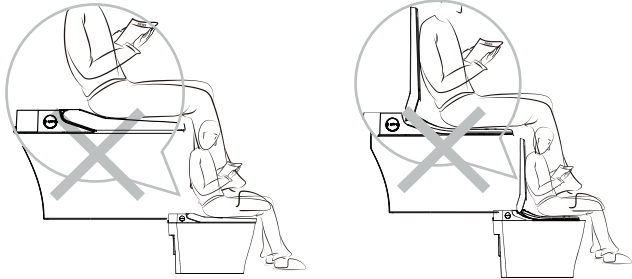

Do not sit on the seat cover when it is closed, or do not lean against the cover when it is open.  
-- Doing so may scratch the seat cover and cause malfunction.



Please do not use cloth covers or mats on the seat.  
-- Failure to do so will result in poor seat induction.

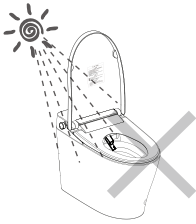

Please keep out of direct sunlight.  
--Otherwise, it will lead to discoloration of the product  
and it will not work properly.



Prohibit



Do not spray urine on the product or the nozzle, otherwise it  
may cause malfunction.

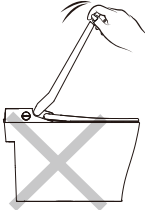

Please do not force the cover and seat ring closed.  
-- otherwise the product may be damaged.

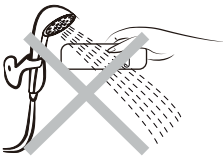

In the daily use of the remote control should avoid contact wit  
the water source, in order to prevent internal water damage.



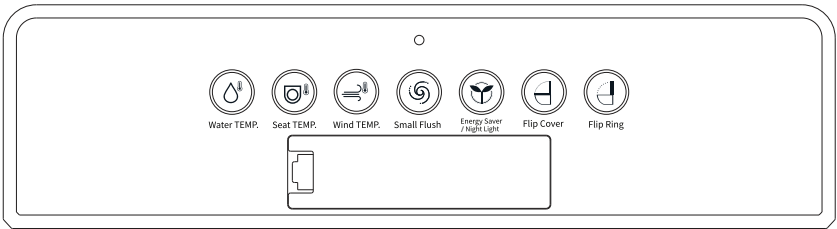
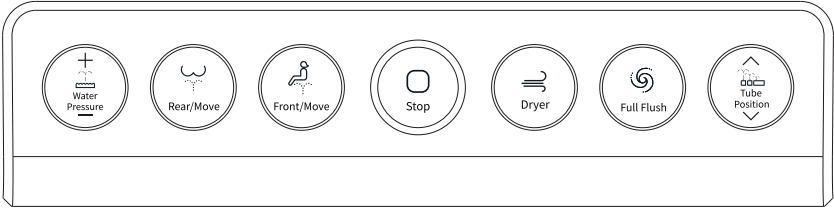

remote control

- The appearance and function are based on the actual object.

### Close the cover and flush

---

Leave the seat for more than 5 seconds, and conduct a ceramic flushing after manually closing the cover within 10 seconds;  
After the system performs an automatic flushing, the cover shall be closed manually within 3 minutes without ceramic flushing; After 3 minutes, manually close the cover and ceramic flushing can be carried out.

### Massage

---

This function can be used only when the cleaning function is enabled.

**Press and hold the 【 Water Pressure+ 】 button for more than 3 seconds to activate the massage function.**

After the function is enabled, the cleaning water pressure changes automatically.

To achieve massage effect. This function is only applicable to rear cleaning and front cleaning.

### Stop

---

It is used to stop the function that the whole machine is running. Long press this button for more than 5 seconds when no seating, then the power of the whole machine can be turned off. When the power of the whole machine is turned off, all functions are stopped and all the indicator lights are extinguished, Pressing the stop button again to exit the standby mode and all functions are restored.

### Full Flush

---

When using the product, press this button and the product will perform a ceramic flushing. Long pressing this button for more than 3 seconds can turn on/off the intelligent flushing function.

**This function does not support continuous operation, you need to wait one minute before the next round of flushing.**

### Half Flush

When using the product, press this button and the product will perform a ceramic half flushing. **This function does not support continuous operation, you need to wait one minute before the next round of flushing.**

### Water Pressure

This function can only be used when the cleansing function is turned on. It is used for water pressure adjustment. The range of water pressure adjustment has three gear of 1-3. The cleansing pressure can be adjusted by pressing **【 + 】** or **【 - 】** button.

### Dryer

In the seated state, press this key to start the "Dryer" function; Drying function is 4 minutes; To stop, press the 'Stop' button.

When open, you can press the "Air Temp." button to adjust the air temperature. The air temperature adjustment range is 0-1-2-3 (0 is normal temperature without heating).

When the drying function is started, the deodorization function automatically stops; After the drying function is turned off, the deodorization function resumes and starts.

Long press the "Dryer" button for more than 5 seconds, you can turn on/off the automatic deodorization function; The deodorization function is disabled by factory default.

### Front/Move

Pressing the button can turn on the bidet cleansing function when seating, so that the washing water can be sprayed from the bidet mouth. The function cleansing period is 4 minutes. If you want to continue cleansing, please press the button again.

Within 4 minutes after the function is turned on:

Pressing the **【 ^∨ 】** button can perform cleansing position adjustment;

Pressing the **【 +/ - 】** button can adjust the water pressure;

Press the **【 Water TEMP. 】** button to adjust the temperature of the water temperature.

**After the Bidet function is turned on, press this key again to turn on/off the female washing reciprocating function.**

## Rear/Move

---

Pressing this button can turn on the rear function when seating, so that the washing water is sprayed from the rear mouth. This function has a cleansing period of 4 minutes. To continue cleansing, press this function again.

Within 4 minutes after the function is turned on:

Pressing the 【 ^v 】 button can perform cleansing position adjustment;

Pressing the 【 Rear/Move 】 button can turn on/off the oscillating function;

Pressing the 【 + / - 】 button can adjust the water pressure;

Press the 【 Water TEMP. 】 button to adjust the temperature of the water temperature.

**After the RearCleansing function is turned on, press this button again to turn on/off the hipcleaning reciprocating function.**

## Automatic flushing

---

1. Leave the seat directly after cleaning, and flush automatically after 10 seconds;
2. Within 5 seconds, the human body shall leave the seat without ceramic flushing;
3. After sitting for more than 5 seconds, the human body should leave the seat and carry out a ceramic flushing;
4. After flushing from the seat, do not flush the cover for the first time within 3 minutes.

## Water TEMP.

---

This function can only be used when the cleansing function is turned on. It is used to adjust the temperature of water temperature.

When cleaning, the temperature adjustment range of water temperature is 0-3 gears (the water temperature is not heated during the 0 gear).

The left indicator shows the current gear.

### Hot & Cold SPA

Press the **【 Water Pressure - 】** button for more than 3 seconds to turn on the Hot & Cold SPA function.

When this function is turned on, warm water and normal temperature water will be alternately sprayed to achieve the effect of alternating hot and cold massage. This function has a cleansing period of 4 minutes, please use as appropriate.

To continue cleansing, press this function button again.

Within 4 minutes after the function is turned on:

Pressing the **【 ^ v 】** button can perform cleansing position adjustment;

Pressing the **【 +/- 】** button can adjust the water pressure

### Self-cleansing

Press and hold the **【 Tube Position ^ 】** button for more than 3 seconds to activate the self-cleansing function.

This function can only be turned on when not seating. When turning on, the cleansing tube will stick out, at this time, the cleansing tube can be cleaned with a soft wet towel or a soft brush, it will end automatically after 2 minutes. To continue, press this button again.

### Tube Position

This function can only be used when the cleansing function is turned on .

It is used to adjust the position of the cleansing tube and It has three adjustable gears: low - middle- high. The cleansing position can be adjusted by pressing **【 ^ 】** or **【 v 】** button.

### Wind TEMP.

Used for air temperature adjustment in warm air drying mode. The adjustment range is 0-3 (0 gear at normal temperature), and the left display lamp will display the current gear. When all indicator bars are off, they are in 0 gear and do not heat.

### Energy Saver/Night Light

---

#### **Energy Saver**

It is used to turn on or turn off the energy saver mode. When the energy saver mode is turned on, the corresponding energy saver indicator lights on the machine will be lightened.

Note: After the energy saver mode is turned on, the energy saver mode will be released automatically, and the energy saver mode will be recovered automatically after leaving the seat for 10 minutes.

#### **Night Light**

Press for more than 3 seconds to turn on or off the Night Light function.

### Flip Ring

---

When not seated, press this key to open or close the seat cover. When both the seat ring and the seat cover are open, press this key directly to close the seat ring and the seat cover, you don't have to press the key to close the seat ring first and then press the key to close the seat cover.

### Flip Cover

---

When not seated, press this key to open or close the seat ring. When both the seat ring and the seat cover are closed, press this key directly to open the seat cover and seat ring, you don't have to press the key to close the seat cover first and then press the key to close the seat ring.

**Press and hold the 【Flip Cover】 key for more than 5 seconds to turn the automatic flip mode on or off.**

Seat TEMP.

---

It is used to adjust the temperature of the seat ring.

The seat temperature adjustment range is 0-3 gears (seat temperature is not heated during 0 gear)

The left indicator shows the current gear.

KYP Function List

Seat temp	<input type="radio"/>	Indicator light	<input type="radio"/>
Hot and cold SPA	<input type="radio"/>	Flip seat/cover	<input type="radio"/>
Seating induction	<input type="radio"/>	Ring cover induction	<input type="radio"/>
Massage	<input type="radio"/>	Self-Cleaning nozzle	<input type="radio"/>
Flush	<input type="radio"/>	Power failure flushing	<input type="radio"/>
Night-light	<input type="radio"/>	Knob switch	<input type="radio"/>
Front Cleansing	<input type="radio"/>	Position cleaning	<input type="radio"/>
Rear Cleansing	<input type="radio"/>	Instantaneous heating	<input type="radio"/>
Close the cover and flush	<input type="radio"/>	Energy Saver	<input type="radio"/>
Reciprocating	<input type="radio"/>	Prewet	<input type="radio"/>
Warm Air	<input type="radio"/>		
Deodorization	<input type="radio"/>		

Attention: “” means to configure this function, “—” means no such function.  
The function is subject to the physical machine

## Knob switch description

A knob switch is on the side of the product body. If the remote controller is damaged or the battery is exhausted, the cleaning and drying functions can be returned on by the knob switch.



Flush: When leaving the seat, tap in the middle to start a flush.

Flush+Dryer: When sitting, press and hold for 3-5 seconds and release to activate the flushing+drying function.

Stop: When sitting, lightly press in the middle to stop the function.

The toilet can only be flushed with this button in the event of a power outage or when the toilet has no power.

Attention: When pressed during ceramic toilet flushing, only one toilet flush is performed.



Front: Rotate clockwise once while sitting to activate female only; Turn it clockwise again during cleaning to activate the female specific reciprocating cleaning mode. One-button automatic (Front): When sitting, rotate clockwise for more than 3 seconds to turn on one-button automatic (Front); During cleaning, rotate clockwise for more than 3 seconds to activate the one-button automatic (Front) reciprocating cleaning mode.

Note: One-button automatic (Front): When the female cleaning function ends or manually stops, it automatically enters the drying function.



Rear: turn counterclockwise once while seated to open one-button buttock cleaning; Turn counterclockwise once more during cleaning to open the reciprocating cleaning mode for hip cleaning. Auto Rear Wash cycle: when the seat is rotated counterclockwise for more than 3 seconds, open the one-button automatic (Rear); When cleaning, rotate counterclockwise for more than 3 seconds, and open the one-button automatic (Rear) reciprocating cleaning mode.

Note: One-click automatic (Rear): When the buttock cleaning function ends or manual stop, the drying/flushing function is automatically entered at the same time.

Note: When the one button female only, one button buttocks cleaning, one button fully automatic (Rear), and one button fully automatic (Front) functions are turned on, the water pressure, pipe position, water temperature, and air temperature are the gears set during the last use.



The appearance and function are based on the actual object.

## Indicator Light Description

- ① Power supply: Instructs the intelligent toilet power on/off;
- ② Energy Saving: When the energy saving indicator is on, the whole machine is in a state of energy saving;
- ③ Seat temperature: When the seat temperature indicator light is on, the seat temperature is set in the heating state;
- ④ Intelligent flush: When the light is on, the machine is in the intelligent flushing mode;
- ⑤ The seat: When the seat light is on, it indicates that the seat sensing function has been activated.

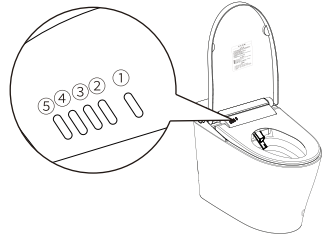

## Ring cover induction

When the human body is close to the foot feeling area and the seat cover is closed, the machine will automatically open the seat cover; Close to the second time, automatically open the seat ring; Near the third time, automatically close the seat ring and seat cover; In the seated state, the function fails.

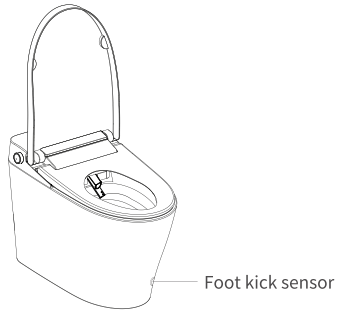

## Power Outage Flushing

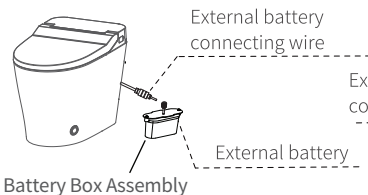
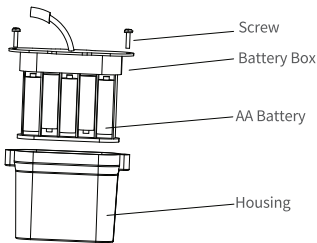

1. Use a Phillips screwdriver to remove the two screws here;
  2. Remove the battery box and place 10 cells AA batteries (pay attention to the positive and negative of the battery);
  3. Replace the battery box and tighten the screws;
  4. Connect the component of the battery box with the connection wire of entire machine battery box (the battery box connection wire is located in the shown place);
  5. After a power outage, press the knob lightly to perform ceramic flushing.
- Note: Customers are advised to purchase AA batteries by themselves.

Note: Customers are advised to purchase AA batteries by themselves.

## Maintenance Instructions

### Daily Maintenance Method

Please remove the removable accessories before maintenance, so that the maintenance is more convenient.

Before maintenance:

- Make sure the power is off.
- Do not allow water to enter the product during maintenance.
- Be sure to wipe the detergent after cleaning, to avoid its residue in the body of the product and the gap between the toilet.

### Product surface maintenance

- Please wring out the soaked soft cloth before use.
- ⊗ Do not rinse with water (causing malfunction).
- ⊗ Do not wipe with a dry cloth or paper towel (causing scratches)



- If the product surface is dirty, use a neutral detergent for the bathroom. After dilution, apply a small amount on the soft cloth to wipe the product, and then immediately remove the residual detergent on the surface with a clean damp cloth.

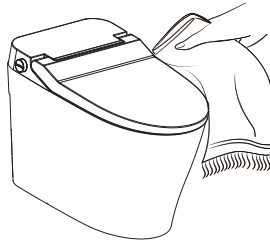
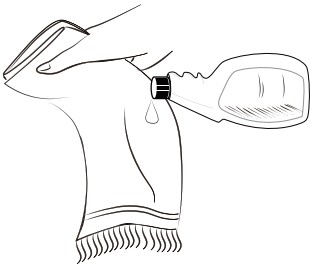

## Nozzle Maintenance

- When not seated, Press and hold the 【 Tube Position  $\wedge$  】 button for more than 3 seconds to activate the self-cleaning function.
- When the machine is on, the cleaning nozzle tube will extend,at this moment, the tube can be cleaned with a soft wet towel or a soft brush.It will automatically end after 2 minutes. Press this button to continue again.
- Do not manually pull or push the nozzle,so as not to damage the product and cause failure.



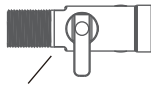

When not used for a long time

- 1 --- Close the inlet valve to stop the water inlet

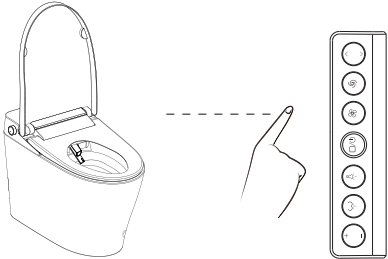

Disabled
- 2 --- Use a wet towel to make the seat ring sense, then press the general hip cleaner button on the remote control or the operation panel several times, as so to run out of water inside the machine

- 3 --- Disconnect the power supply

- 4 --- Remove the battery from the remote control.

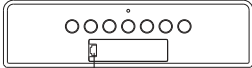

Press and hold here to lift upwards

Attention

- △ It is strictly forbidden to spray water onto the toilet bowl or to the dry air outlet.
- △ If it is installed in a cold weather, keep it in a warm room for 2 hours before installation.

Phenomenon	Confirmation	Treatment
Fail to work	Whether the seat ring sensing area is covered with cloth, mat and other items.	Please remove the cloth cover, mat, etc.
	Whether there is a power cut	Please wait for power restoration
	Is the socket loose or poorly connected	Please plug in the plug to ensure good power supply
	If the power button is pressed	Please press the power button of the toilet
No washing water output	Is the water shut off	Please wait for the water supply to be restored
	Whether the inlet angle valve is open	Open the inlet angle valve
	Is the filter clogged with dirt	Please clean the filter
	Whether the water supply hose is bent or blocked	Exclude water supply hose bending
Insufficient washing water	Is the water pressure set too low	Adjust water pressure
	Is the filter clogged with dirt	Please clean the filter
	Is there a blockage in the nozzle	Please clean the nozzle
Water temperature is not hot enough	Is the water temperature set too low or in normal temperature	Please follow P19, P20, P21, P22, P23, P24 pages to reset the water temperature.
Water stop during washing	<ul style="list-style-type: none"> <li>Pressing the [Rear] button or the [Front] button, it will automatically stop in about 240 seconds.</li> <li>Leave the seat in the midway</li> </ul>	Please press the [Rear] button or the [Front] button again.

## Troubleshooting

Phenomenon	Confirmation	Treatment
Insulation seat ring is not hot	Whether the thermal insulation temperature is set to low or off.	Please follow P19.P20.P21.P22.P23.P24 pages to reset the seat temperature.
	Whether it is set in the energy saving state?	Please press the the energy saving button on operation key to be out of the energy saving mode.
	Whether there is a power outage?	please wait for power supply recovery.
Warm air temperature is low	Whether the warm air drying temperature set too low or off?	Please follow P19.P20.P21.P22.P23.P24 pages to reset the warm air drying temperature.
Warm air stops during operation	<ul style="list-style-type: none"> <li>• Press the warm air drying button to stop automatically after about 4 minutes.</li> <li>• Leave the seat in the midway</li> </ul>	Please press the Warm Air drying button again

## Technical Parameter

Name	KYP Manual of Intelligent toilet suit
Rated power	1080W ①
Maximum power	1500W ②
Rated voltage	AC240V~ 50Hz
Water inlet temperature	1-35°C
Ambient temperature	1-40°C
Water supply method	Waterway direct connection
Water pressure operating range	0.07Mpa- 0.75Mpa, flow rate ≥20L/min
Safety device	Leakage protection device, water overpressure protection device

Name		KYP Manual of Intelligent toilet suit	
Cleaning device	Heating method	Instant	
	Warm water temperature	Four grades(normal temperature - about40°C)	
	Ejection amount	Rear	About0.3 - 0.75L/min
		Front	About0.3 - 0.75L/min
		Self-cleaning	About0.3 - 0.75L/min
	Spray method	Rear	Bubble soft spray
		Front	Bubble soft spray
Safety device	Temperature controller, temperature fuse, temperature sensitive switch		
Deodorizing device	Deodorant	Acticarbon	
	Air volume	0.2m <sup>3</sup> /min	
Drying device	Wind temperature	Four grades air temperature ③ (normal temperature- about55°C)	
	Safety device	Temperature controller, temperature fuse	
Insulated seat ring	Surface temperature	Four grades (Normal temperature-approx. 40°C)	
	Safety device	Temperature controller, temperature fuse	
	Closing	Cushioning device of seat and cover	
	Power	45W	

Executive standard: GB4706.1, GB4706.53 GB 38448

Note: ① test conditions: keep the ambient temperature at 20 °C, water inlet temperature within 14 - 16 °C, water inlet dynamic pressure at 0.2MPa, seat ring temperature at (high grade 3) , water temperature at (high grade 3) , female cleaning water pressure at (highgrade 3), and integralpower of cleaning water from grade 3), female cleaning water pressure at (high grade 3) , and integral power of cleaning water from female cleaning mouth to the end. Test method: set the seat temperature and water temperature to non heating mode, and clean the water channelwith 14-16 °C water for 4 minutes, and then test the integral power according to the test conditions.

② Test conditions: the inlet water temperature is 5 °C, the inlet water dynamic pressure is 0.2MPa, the seat ring temperature (high gear 3) is in the heating mode, the water tempera (high gear 3), the female washing water pressure (high gear 3), and the maximum washing power measured. Test method: set the seat temperature and water temperature to non heating mode, and clean the water channelwith 5 °C water for 4 minutes, and then test the maximum power according to the test conditions.

③ The above ① and ② test conditions do not enter the hydraulic massage mode.

Parts	hazardous material					
	Pb	Hg	Cd	Cr(VI)	PBB	PBDE
Circuit board	X	O	O	O	O	O
Plastic parts	O	O	O	O	X	X
electric machinery	X	O	O	X	O	O
other parts	X	O	O	O	O	O



This table is drawn up according to the provisions of SJ/T11364

O: indicates that the hazardous substance in all homogeneous materials of the component is below the required limit according to GB/T 26572.

X: indicates that the hazardous substance is at least one of the homogeneous materials, which exceeds the required limit according to GB/T 26572.



This sign indicate that the product has an environmental protection period of 10 years under normal use.

## Warranty and Service Card

Product number			
Serial number		Date of purchase	
Telephone			
City		Dealer name	

### Maintenance regulations:

1. Follow the instructions and precautions for use. If there is a malfunction after normal use, free maintenance will be carried out during the warranty period.
2. Please contact with the Purchasing Office and Customer Service Center of **MERCIO**  
Please show the service card when repair.
3. During the warranty period, the following cases are charged for repair.
  - Failures due to improper or negligent use and failures due to improper repair or modification.
  - Failure or damage to the relocation of the product.
  - Failure or damage due to fire, earthquake, flood, lightning and other natural disasters, pollution or abnormal voltage.
  - Failure or damage due to the use of non-standard power sources (voltage, frequency).
  - For use other than in general household, malfunction or damage.
  - If this service card is lost.
  - When the customer name, purchase place, installation date light content, or unauthorized modification of content is not filled in this service card.
4. This repair card is no longer issued. Please keep it safe.

### About the service:

#### Customer rights

The customer has the right to repair free of charge in the event of a failure within one year from the date of purchase.

However, due to customer's fault or natural disaster, even if it is under warranty, it will be charged for repair.

First union: preserved by customer







Product Name:  
Intelligent toilet suit

Product category:  
See Box Label

Machine water consumption:  
See Box Label

Inspector : 

Date of Produce :

The form is enclosed in a square border. It contains several fields with underlines. The "QC PASS" logo is a circle with "QC" above a horizontal line and "PASS" below it. There are corner brackets on the right side of the form.