

# Installation Instruction

## CARE AND MAINTENANCE

To enable you to use the washbasin safely and hygienically, please follow the instructions below to clean and maintain the washbasin.

1. It is recommended to wash the basin frequently.
2. Please clean only use warm soapy water and then dry with a soft cloth.
3. Do not use wire brushes, detergents, abrasives and other supplies to clean, to prevent abrasion on the surface of the basin.
4. Do not use hard or sharp objects to scratch the surface of the basin.
5. Pay attention to avoid collision.

It is recommended to use wax to maintain the washbasin every six months.

## YOUR WALL MOUNT BASIN KIT WILL CONTAIN

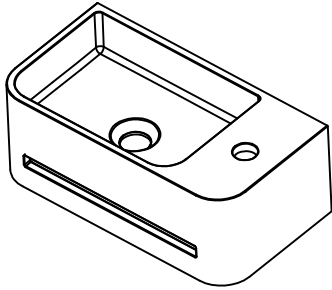

Concrete Basin x 1



Drainer x 1

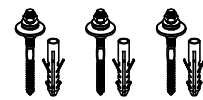

Expansion screws x 3

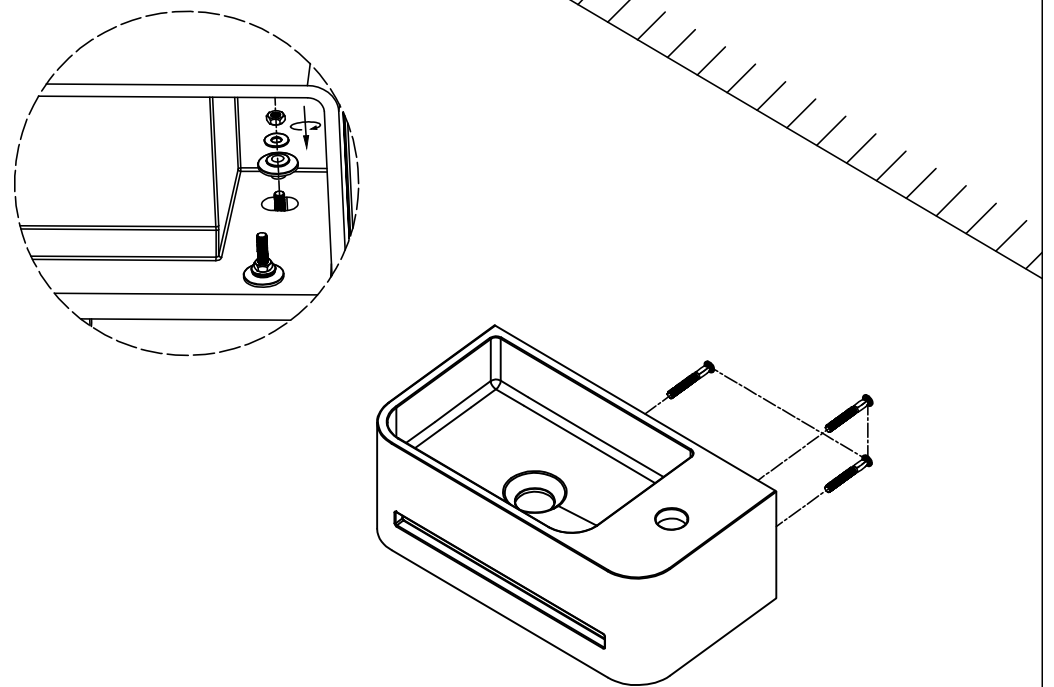
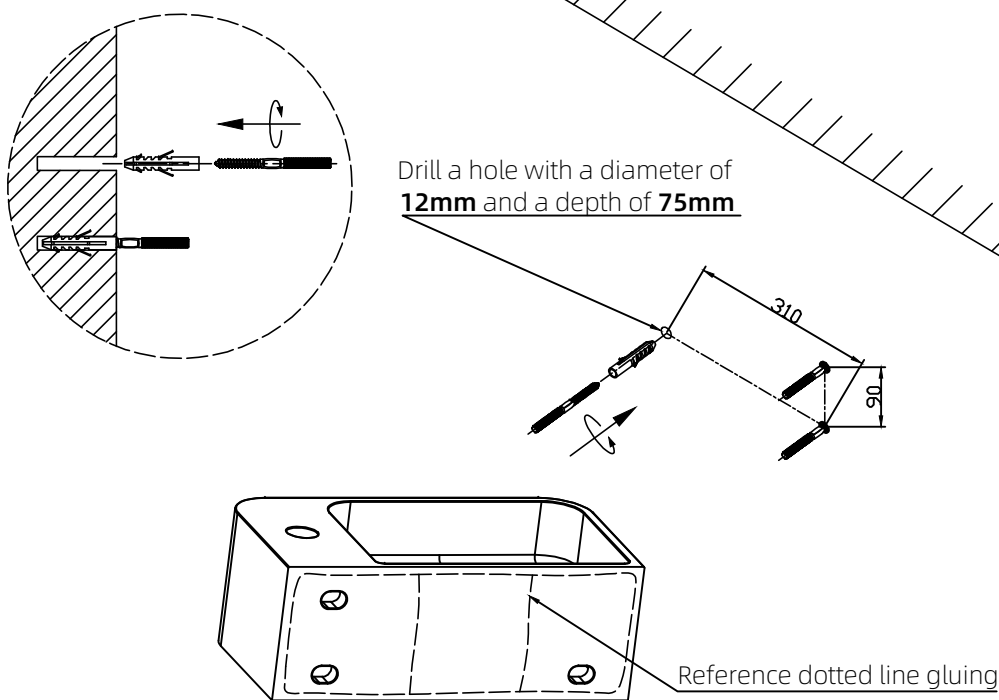

**1.** Drill screw holes on the wall, secure the screws to the wall with a wrench, and apply silicone to the back of the basin.

**2.** Thread the screw through the hole on the back of the basin, adjust the position of the basin, and then lock it with a nut.

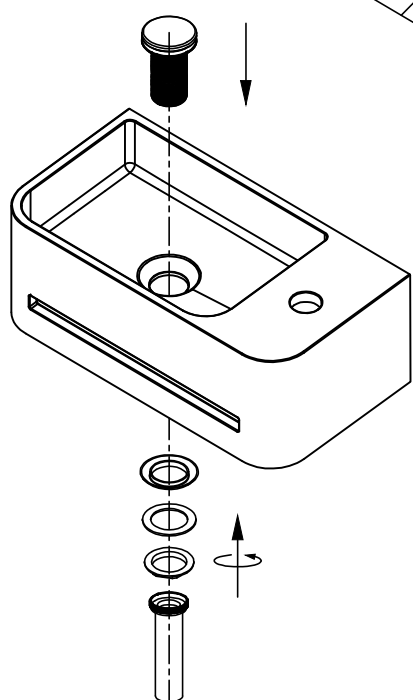

**3.** Thread the drainer through the holes in the basin, and then lock it with the copper ring of the drainer.

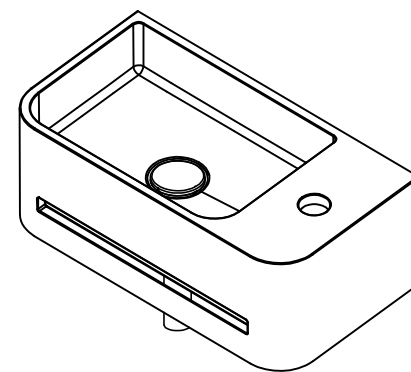

**4.** After installing the basin, wait for the silicone to dry before installing other pipes.